

DR-HSH004B 人感款说明书

尺寸：105 x 150 mm

材质：封面封底：80g 书纸

内页：80g 书纸

印刷要求：双面印刷，文字线图清晰

装订方式：骑马钉装订

* 此页删除不做印刷

DREO

PTC FAN HEATER WITH MOTION SENSOR

USER MANUAL

www.dreo.com

DR-HSH004B

Looking for help?

Contact us to get expert support.

 support@dreo.com  (888) 290-1688  www.dreo.com

Mon - Fri, 9:00 am-5:00 pm PST/PDT

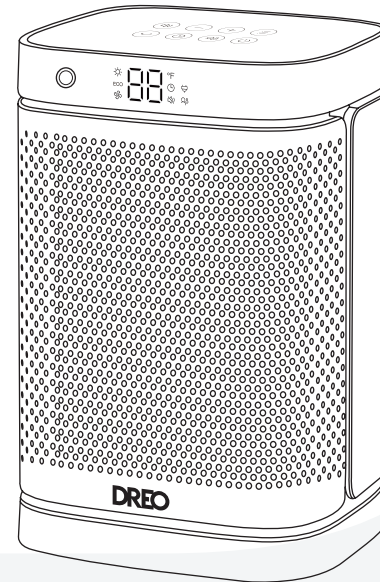

”

Thanks for Choosing DREO!

Your support means the world to us. We hope you enjoy our product as much as we did creating it.

EXTEND YOUR WARRANTY FOR FREE

Scan or visit dreocom.com/warranty

to extend your warranty for free by registering your product. If you have any product issues, we always stand ready to help.



 support@dreocom.com

 www.dreocom.com

 (888) 290-1688

Mon - Fri, 9:00 am-5:00 pm PST/PDT

CONTENTS

1

IMPORTANT SAFETY INSTRUCTIONS

1-4

3

USING YOUR HEATER

6-11

5

TROUBLE-SHOOTING

14-15

2

KNOWING YOUR HEATER

5

4

CLEANING AND MAINTENANCE

12-13

6

DREO CUSTOMER CARE

16-17

IMPORTANT SAFETY INSTRUCTIONS



When using electrical appliances, basic precautions should always be followed to reduce the risk of fire, electric shock, and injury to persons and hyperthermia, including the following:

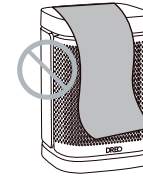

Do not cover the air inlet and outlet while in operation.



Do not use the fan heater near flammables and combustibles.

GENERAL SAFETY

1. Read all instructions before using this heater.
2. This heater is hot when in use. To avoid burns, do not let bare skin touch hot surfaces.
3. Use the handle to move this heater.
4. Extreme caution is necessary when any heater is used by or near children or invalids and whenever the heater is left operating and unattended.
5. Do not insert or allow foreign objects to enter any ventilation or exhaust opening as this may cause an electric shock or fire, or damage the heater.
6. The output of this heater may vary and its temperature may become hot enough to burn exposed skin. Use of this heater is not recommended for persons with a high sensitivity to heat or an inability to react to avoid burns.
7. Do not attempt to modify or repair the product by yourself. Doing so could void the warranty and cause damage or personal injury. Only a repair technician may disassemble or repair this product.
8. Make sure that no pieces of polystyrene or other packaging material have been left between elements of the appliance. It may be necessary to pass over the appliance with a vacuum cleaner.
9. If the machine is not working as it should, has received a sharp blow, has been dropped, damaged, left outdoors, or dropped into water, do not use and contact Customer Support.
10. There may be a trace of smoke or odor when the unit is first operated. This indicates that a drop of oil fell on the heating coil during the manufacturing process. It will quickly evaporate and should not re-occur.

LOCATION SAFETY

1. Do not use outdoors.
2. Ensure the heater is on a stable, secure surface to eliminate the potential of tipping it over.
3. Keep combustible materials, such as furniture, pillows, bedding, papers, clothes, and curtains at least 3 feet (0.9 m) from the front of the heater and keep them away from the sides and rear.
4. A heater has hot and arcing or sparking parts inside. Do not use it in areas where gasoline, paint, or flammable liquids are used or stored.
5. To prevent a possible fire, do not block air intakes or exhaust in any manner. Do not use on soft surfaces, like a bed, where openings may become blocked.
6. This heater is not intended for use in bathrooms, laundry areas and similar indoor locations. Never locate heater where it may fall into a bathtub or other water container.

ELECTRICITY SAFETY

1. Always unplug heater when not in use.
2. Do not operate any heater with a damaged cord or plug or after the heater malfunctions, has been dropped or damaged in any manner. Discard heater, or return to authorized service facility for examination and/or repair.
3. Do not run cord under carpeting. Do not cover cord with throw rugs, runners, or similar coverings. Do not route cord under furniture or appliances. Arrange cord away from traffic area and where it will not be tripped over.
4. To disconnect heater, turn controls to off, then remove plug from outlet.
5. Always plug heaters directly into a wall outlet/receptacle.
6. Never use with an extension cord or relocatable power tap (outlet/power strip).
7. If there is a loose fit between the plug and the socket or the plug becomes very hot, the socket may need to be replaced. Check with a qualified electrician to replace the socket.
8. It is normal for the plug and cord to feel warm to the touch.
9. A plug or cord which becomes hot to the touch or becomes distorted in shape may be a result of a worn electrical outlet. Worn outlets or receptacles should be replaced prior to further use of the heater. Plugging the heater into a worn outlet / receptacle may result in overheating of the power cord or fire.
10. This appliance has a polarized plug (one prong is wider than the other). To reduce the risk of electric shock, this plug is intended to fit in a polarized outlet only one way. If the plug does not fit fully in the outlet, reverse the plug. If it still does not fit, contact a qualified electrician. Do not attempt to rig this safety feature.

11. Hyperthermia can result in death. Symptoms of hyperthermia include high body temperature, headache, nausea, vomiting, tiredness, dizziness, fainting, and rapid pulse. If you begin to experience symptoms related to hyperthermia, turn off the heater and seek medical attention.
12. To avoid excessive room temperatures which can cause hyperthermia: DO NOT leave product running unattended in a confined space around infants, or individuals with reduced physical, sensory, or mental capabilities.
13. Use this heater only as described in this manual. Any other use not recommended by the manufacturer may cause fire, electric shock, or injury to persons.
14. **CAUTION - High temperature, keep electrical cords, drapery, and other furnishings at least 3 feet (0.9 m) from the front of the heater and away from the side and rear.**
WARNING - Risk of Hyperthermia.



WARNING - Risk of Heat Stroke (Hyperthermia)

**Hyperthermia can result in death in infants or others
Use caution to avoid overheating individuals
Read and follow all instructions before use**

DANGER - High temperatures may be generated under certain abnormal conditions. Do not partially or fully cover or obstruct the front of this heater.

FOR HOUSEHOLD USE ONLY READ AND SAVE THESE INSTRUCTIONS

Gentle Reminder:



Check the appliance regularly and refer to TROUBLESHOOTING or contact our customer support if it shows any of the following signs:

- Power cord or plug is damaged.
- Loud noise, unusual smell or excessive heat.

Specifications

Model	DR-HSH004B
Rated Power	1500W
Input	120V~ 60Hz
Remote Control Battery	CR2025, 3V

HOT SURFACE

THE FRONT SURFACE CAN BE VERY HOT DURING USE.
DO NOT TOUCH WHEN IN USE.

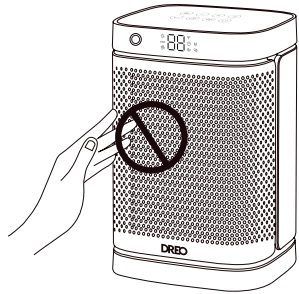

KNOWING YOUR HEATER

Package Contents

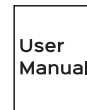
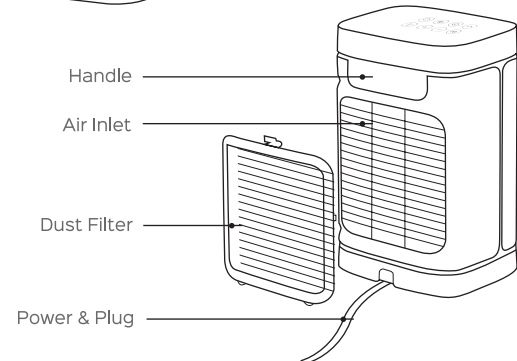
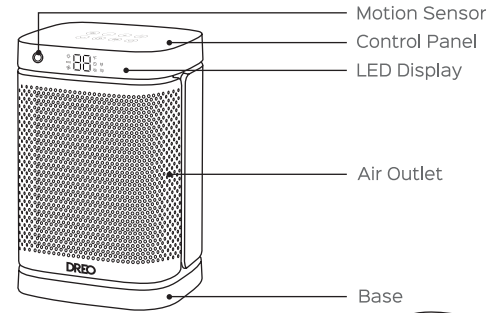

USING YOUR HEATER

Control Panel

3



Power On/Off

Touch to turn the heater on or off.

Note:

- When the heater is plugged into the electric outlet, the power indicator will light in red.
- Once turned off, a 30-second countdown will show up on the display as the fan will continue to run for 30 seconds to blow out the remaining heat.



Mode Settings

Touch to switch between -> ECO -> .



Power Heat with three heating levels:
H1(900W), H2(1000W), H3(1500W).

ECO The heater will automatically select its optimal heating power, depending on the difference between the set temperature (41-95 °F) and ambient temperature.

Note:

- When the ambient temperature reaches the set temperature, the heater will turn off automatically in 30 seconds.
- When the ambient temperature drops below the set temperature, the heater will operate on medium or high power (1000W or 1500W), depending on the difference between the two temperatures.



Fan only.



Mute/Unmute

Touch to turn on/off the button sounds.



Auto-Off Timer

- When the heater is on, touch to set a timer (0-12h). After the timer ends, the heater will turn off automatically.
- To cancel, set the timer to 0 hour.



Heat Level / Temperature

- In Power Heat mode, touch or to adjust the heating level.
- In ECO mode, touch or to adjust the set temperature.



Note:

In ECO mode, the heater will turn off automatically when the set temperature has been reached. If your heater turns off frequently, please raise the set temperature, or switch to Power Heat mode.

Oscillation

Touch to turn on or off oscillation.



Motion Sensor

Touch to turn the motion sensor on or off.

Note:

1. When motion sensor is on, the heater will go into standby mode if you are out of range or motionless for more than 3 minutes. It will begin heating again once motion is detected in range (up to a distance of 6.5 feet and with an angle of 60 degrees as shown on the diagram below).

6.5 feet



2. The sensor may not be able to detect normally under the following circumstances:

- Your body temperature is close to ambient temperature.
- Your thick clothes block thermal radiation from your body.
- You don't make motions for a long period of time.
- Curtains or plants are being blown by air conditioning or heaters.
- There are reflective materials such as mirrors and polished metals nearby.
- Direct sunlight is hitting the sensor and its detection range.
- Pets, heaters, and other objects are emitting thermal energy.

LED Display

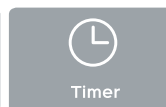

More Features

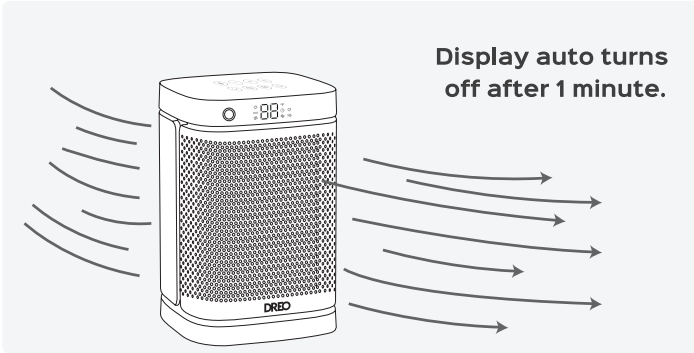

Memory Function

The heater will remember its last settings (temperatures, working modes, oscillation status) once turned on again.

24-Hour Auto Off

This feature is not ON by default.

When this feature is ON, the heater will shut off automatically after continuously running for 24 hours.

Long press the Timer button  for 3 seconds to turn this feature ON/OFF when this heater is on standby. The display will show "00" and "0F" respectively.

Tip-Over Protection

When the heater is tipped over, it will shut off automatically with the error code "P4" on the display.

Overheat Protection

When the heater overheats, it will shut off automatically with the error code "FF" on the display.

Remote Control

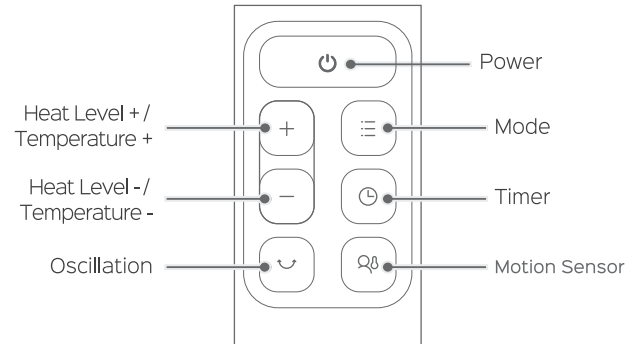

Battery Replacement

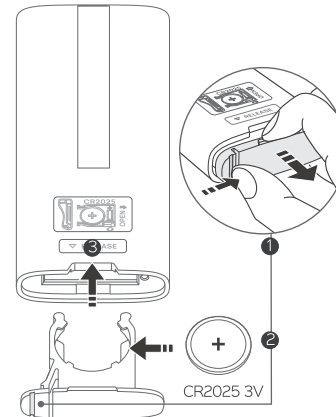

- 1 Keep the locking tab pressed while pulling out the battery holder from the slot at the back.
- 2 Replace with the same battery type with the (+) side facing up.
- 3 Push in the holder until securely locked in place.

Note: If the appliance doesn't respond when using the remote control in close range please consider replacing the battery.



WARNING

- **INGESTION HAZARD:** This product contains a button cell or coin battery
- **DEATH** or serious injury can occur if ingested.
- A swallowed button cell or coin battery can cause **Internal Chemical Burns** in as little as **2 hours**.
- **KEEP** new and used batteries **OUT OF REACH** of **CHILDREN**
- **Seek immediate medical attention** if a battery is suspected to be swallowed or inserted inside any part of the body.



- a) Remove and immediately recycle or dispose of used batteries according to local regulations and keep away from children. Do NOT dispose of batteries in household trash or incinerate.
- b) Even used batteries may cause severe injury or death.
- c) Call a local poison control center for treatment information.
- d) Compatible battery type: CR2025.
- e) Battery nominal voltage: 3.0 Vdc
- f) Non-rechargeable batteries are not to be recharged.
- g) Do not force discharge, recharge, disassemble, heat above (rated temperature: 140 °F) or incinerate. Doing so may result in injury due to venting, leakage or explosion resulting in chemical burns.
- h) Ensure the batteries are installed correctly according to polarity (+ and -).
- i) Do not mix old and new batteries, different brands or types of batteries, such as alkaline, carbon-zinc, or rechargeable batteries.
- j) Remove and immediately recycle or dispose of batteries from equipment not used for an extended period of time according to local regulations.
- k) Always completely secure the battery compartment. If the battery compartment does not close securely, stop using the product, remove the batteries, and keep them away from children.

CLEANING AND MAINTENANCE

4

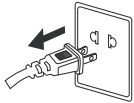

Always turn off and unplug before cleaning.

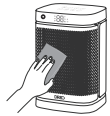

Outer Surface

Use a soft, dry cloth to gently wipe clean the outer surface.

Dust Filter

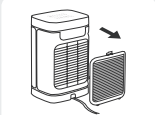

1. Pull out the filter from the back.



2. Rinse the filter under running water.



3. Wait until dry.

TIP: For best performance, please clean the filter every 2-4 weeks.



Air Inlet

Use a soft, dry cloth or a cotton-tipped swab to remove any dust from the air inlet.

⚠ ATTENTION



DO NOT unscrew the unit.



DO NOT use cleaning agents.

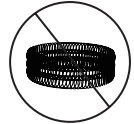

DO NOT use abrasive scrubbers.



Fire or electrical shock hazard. **DO NOT** immerse the main unit in water. **NEVER** allow water to get inside the heater.



Except for cleaning, any servicing should be performed by an authorized service representative.

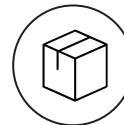

Store in a cool, dry area and keep the cable out of high-traffic areas to avoid tripping hazards.

TROUBLESHOOTING

5

Problem	Possible Causes	Solution
Malfunction codes on LED display	E2 - Temperature sensor short circuit	Unplug it from the power source and contact Customer Support.
	E1 - Temperature sensor open circuit	Unplug it from the power source and contact Customer Support.
	FF - Overheat Protection	Unplug and wait for it to cool down before plugging in again.
	P4 - Tip-Over Protection	Place the heater back on a flat, level and stable surface.
Heater does not start	Power cord is not properly plugged in.	Connect the plug to a powered electrical outlet.
	Overheat protection has been activated.	Unplug and allow it to cool. Remove any objects on or near the heater.
Heater does not start	No power is passing through the unit.	Ensure that your circuit breaker or fuse is working properly.
		Ensure that your heater is placed on a flat and even surface.
	The set temperature is lower than the ambient temperature.	Ensure that the temperature is set to be higher than the ambient temperature.

The heater suddenly stops during heating.	The temperature exceeds the threshold of the thermal cutoff.	Turn off and unplug the unit. Allow it to cool and plug into the electrical outlet again.
	The heater is tipped over.	Place it on a flat, level and stable surface.
	In ECO mode, the heater will turn off automatically when the set temperature has been reached.	This is normal. If your heater turns off frequently, please raise the set temperature, or switch to Power Heat mode.
I've turned on the motion sensor but the heater is not heating even I'm still around.	You're out of range	Make sure you're in the range of the sensor (the sensor will detect motion up to a distance of 6.5 feet and with an angle of 60 degrees).
	No motion is detected.	Try making motions, such as moving your hands or feet.
	The sensor is blocked.	Remove any obstructions in front of the heater.
	The sensor is dirty.	Clean the sensor with a dry, soft cloth.
	There is little difference between your temperature and ambient temperature.	In summer, your body temperature may get close to ambient temperature; in winter, your coat and gloves may block thermal radiation of your body.
The heater keeps heating even there is nobody around.	The heater has detected thermal motions	Check for any moving objects such as oscillating fans, swaying plants, fluttering curtains, and active pets.

If your problem is not listed or still persists, contact our Customer Support (see page 17).

DREO CUSTOMER CARE



Default 12-Month Warranty

This appliance is covered by Dreo warranty for 12 months from the date of its original purchase.

Extend Your Warranty

Extend your warranty by registering your new appliance on our website <https://dreo.com/warranty>.

The warranty will not apply in cases of:

1. Accident, misuse, or repairs performed by unauthorized personnel.
2. Any unit that has been tampered with or used for commercial purposes.
3. Normal wear and tear of wearable parts.
4. Use of force, damage caused by external influences.
5. Damage caused by non-observance of the User Manual, e.g. connection to an unsuitable mains supply or noncompliance with the instructions.
6. Partially or completely dismantled appliances.
7. Defects caused by or resulting from damages from shipping or from repairs, service, or alteration to the product or any of its parts that have been performed by a repair person not authorized by Dreo.

We can only provide after-sales service for products that are sold by Dreo or Dreo authorized retailers and distributors. If you have purchased the appliance from a different place, please contact your seller for return and warranty issues.

FCC Statement

This device complies with Part 15 of the FCC Rules.

This equipment has been tested and found to comply with the limits for a

Class B digital device, pursuant to Part 15 of the FCC Rules. These limits are designed to provide reasonable protection against harmful interference in a residential installation. This equipment generates, uses and can radiate radio frequency energy and, if not installed and used in accordance with the instructions, may cause harmful interference to radio communications. However, there is no guarantee that interference will not occur in a particular installation.

Please note that changes or modifications of this product is not expressly approved by the party responsible for compliance could void the user's authority to operate the equipment. If this equipment does cause harmful interference to radio or television reception, which can be determined by turning the equipment off and on, the user is encouraged to try to correct the interference by one or more of the following measures:

- Reorient or relocate the receiving antenna.
- Increase the separation between the equipment and receiver.
- Connect the equipment into an outlet on a circuit different from that to which the receiver is connected.
- Consult the dealer or an experienced radio/TV technician for help.

This device complies with Part 15 of the FCC Rules. Operation is subject to the following two conditions: (1) this device may not cause harmful interference, and (2) this device must accept any interference received, including interference that may cause undesired operation.

Rev_14_EN

We're Here to Help!

 (888) 290-1688 Mon - Fri, 9:00 am-5:00 pm PST/PDT

 support@dreo.com

 www.dreo.com

 Shenzhen Hesung Innovation Technology Co., LTD

 26F, Bldg A7, Creative City, Shenzhen, China



MADE IN CHINA Intertek